

PR2P21

A

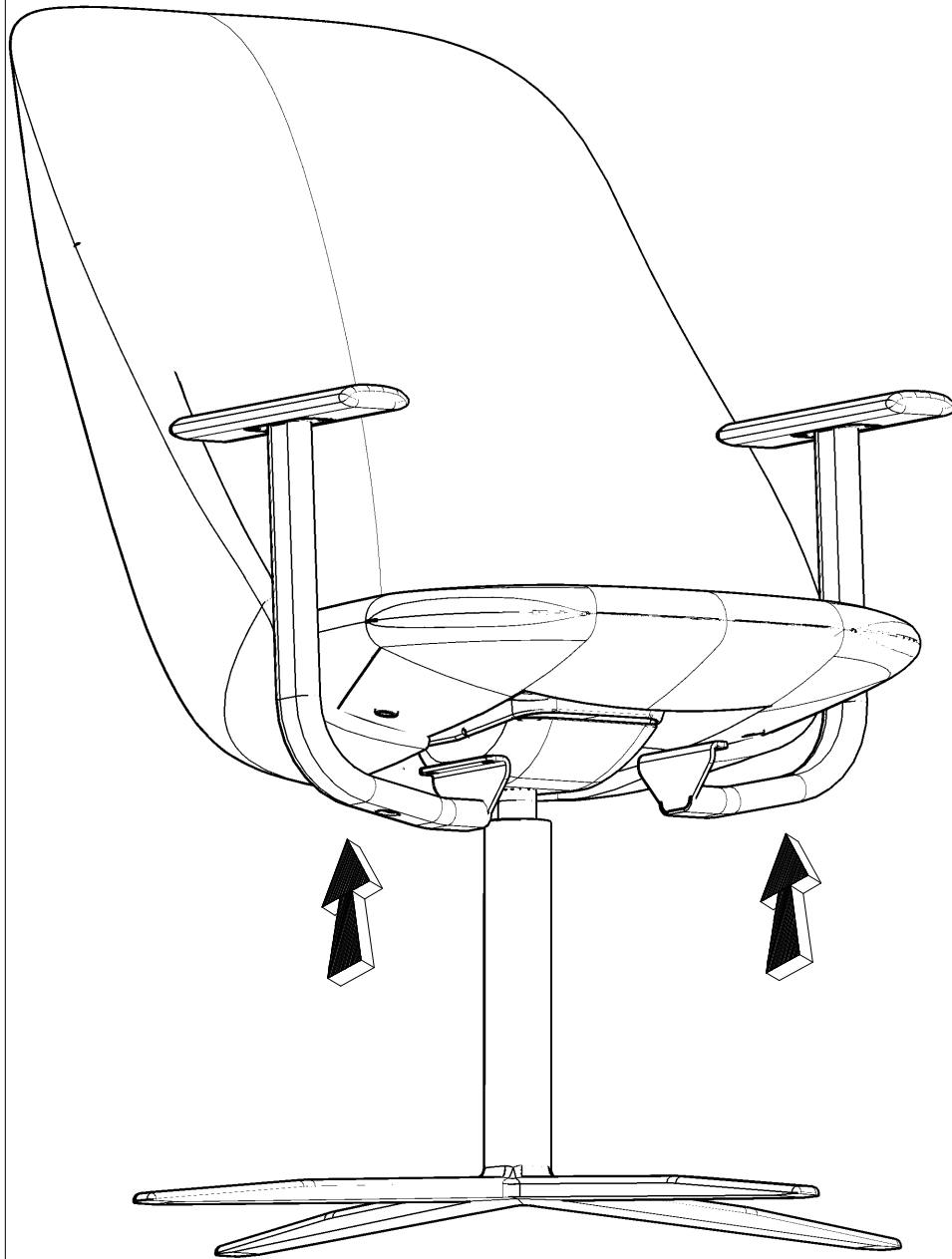

B

