



BuzziPleat

Product Specification Sheet

This document contains technical information about the BuzziPleat



www.buzzi.space

A series of architectural solutions by 13&9 Design

The BuzziPleat reinterprets ancient techniques used in fashion design, like smocking and pleating, to create large-scale, yet lightweight sculptural forms, made of sound-absorbing BuzziFelt. Architectural folds maximize surface area, delivering exceptional acoustic performance.

Design by 13&9 Design

General

- 🏷️ BuzziPleat Edel | BuzziPleat Edel Long | BuzziPleat Ripple
Fixing: Wall | Suspended
- 🌲 BuzziFelt Pleat
OffWhite or Black lace
Metal support black
- ⋯ Fixation: wall mounted | ceiling suspended
Black or Alu cables 2 or 5 m | 78.74" or 196.85"
Optional extra layer BuzziFabric

Acoustics



Absorption



Diffusion



Mid tone



High tone

Certifications



Content

Configurations	3	Fixing Systems	7
Fabrics	6	Dimensions	8
Fabrics	6	Acoustics	10

Configurations

BuzziPleat Ripple Suspended

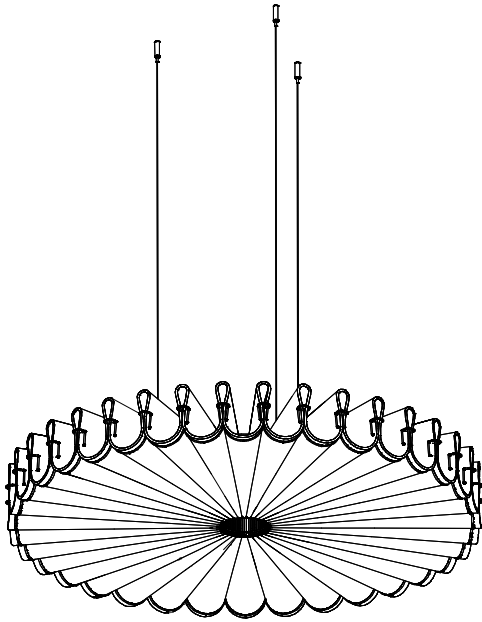

◆ M, L

BuzziFelt Pleat

🌲 OffWhite or Black lace
Metal Support Black

M: Ø 100 cm H 13 cm

Ø 39.37" H 5.21"

✂ L: Ø 150 cm H 19,5 cm

Ø 59.06" H 7.68"

⚖ M: 5,2 kg | 11.46 lbs
L: 10,9 kg | 24.03 lbs

Lace: OffWhite or Black

⋮ Optional extra layer BuzziFabric (only in combination with OffWhite or Anthracite Felt)

Black or Alu cables 2 or 5 m | 78.74" or 196.85"

⚠ If installing on suspended ceiling, verify load capacity prior to installation.

BuzziPleat Edel Suspended

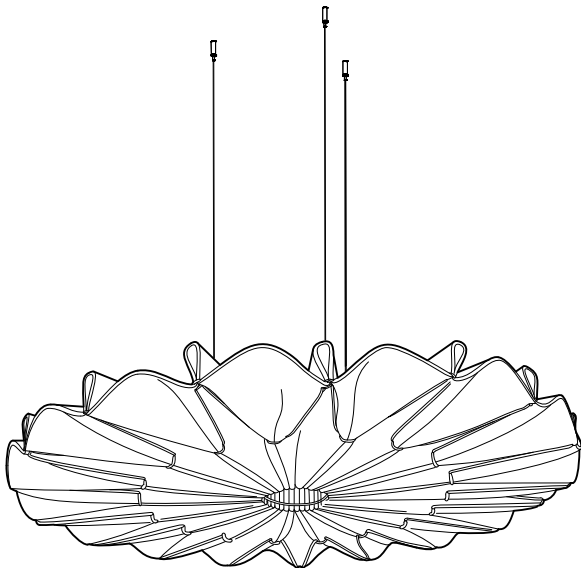

◆ M, L

BuzziFelt Pleat

🌲 OffWhite or Black lace
Metal support black

M: Ø 100 cm H 9 cm

Ø 39.37" H 3.54"

✂ L: Ø 150 cm H 13,5 cm

Ø 59.06" H 5.31"

⚖ M: 4,2 kg | 9.26 lbs
L: 8,9 kg | 17.62 lbs

Lace: OffWhite or Black

⋮ Optional extra layer BuzziFabric (only in combination with OffWhite or Anthracite Felt)

Black or Alu cables 2 or 5 m | 78.74" or 196.85"

⚠ If installing on suspended ceiling, verify load capacity prior to installation.

BuzziPleat Edel Wall Mounted

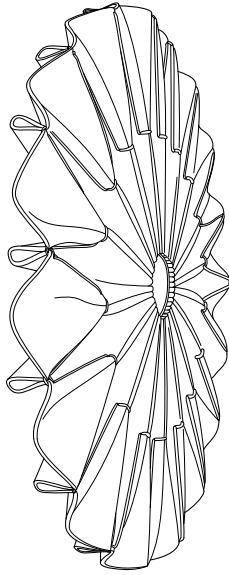

📏 M, L

BuzziFelt Pleat
OffWhite or Black lace

🌲 Metal support black
Central Wooden Support in Ash White Wash or
Ash Black Stained

✂ M: Ø 100 cm H 9 cm
Ø 39.37" H 3.54"
✂ L: Ø 150 cm H 13.5 cm
Ø 59.06" H 5.31"

⚖ M: 4,7 kg | 10.36 lbs
L: 9,4 kg | 20.72 lbs

Lace: OffWhite or Black
... Optional extra layer BuzziFabric (only in combination
with OffWhite or Anthracite Felt)

BuzziPleat Edel M Long Suspended

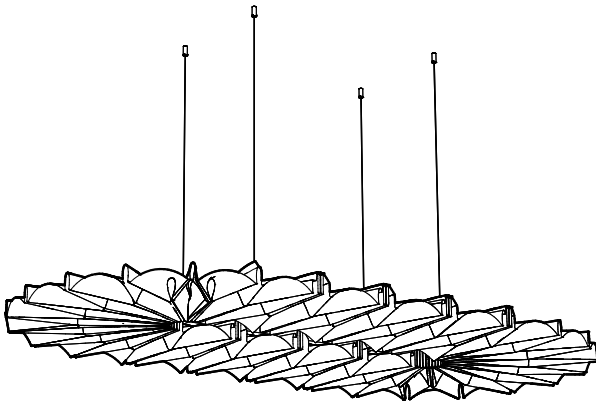

📏 M Long

BuzziFelt Pleat
OffWhite or Black lace
Metal support black

✂ M: Length 185 cm Width 100 cm Height 9 cm
Length 72.83" Width 39.37" Height 3.54"

⚖ 9 kg

Lace: OffWhite or Black
... Optional extra layer BuzziFabric (only in combination
with OffWhite or Anthracite Felt)

⚠ If installing on suspended ceiling, verify load capacity
prior to installation.

BuzziPleat Edel M Long Wall Mounted

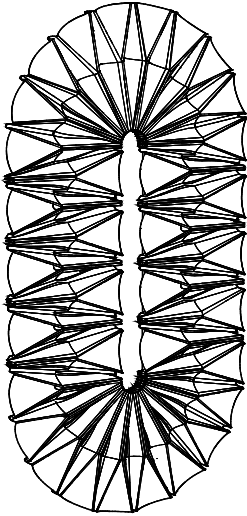

🔪 M Long

BuzziFelt Pleat

🌲 OffWhite or Black lace
Metal support black

✂ M: Length 185 cm Width 100 cm Height 9 cm
 Length 72.83" Width 39.37" Height 3.54"

⚖ 9 kg

⋮ Lace: OffWhite or Black
Optional extra layer BuzziFabric (only in combination
with OffWhite or Anthracite Felt)

Fabrics

Felt

Composition 100% Recycled P.E.T. Felt, latex backing

Weight 1.000 g/m² | 29.49 oz/yd²

Abrasion resistance >7.000 Martindale

Flammability EU: EN 13501.1 + A1/2009 Class B-s1,d0

USA: ASTM E84 Class A certified

Fastness to light USA 5



FE-OffWhite 63*

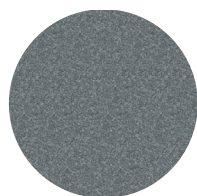

FE-StoneGrey 67

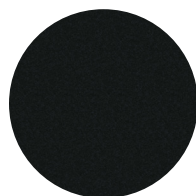

FE-Anthracite 68*

*Extra layer BuzziFabric Possible

Fabric

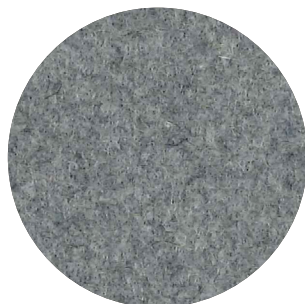

Category A

Composition 70% Recycled Wool, 25% Recycled Polyacryl,
5% Recycled Other Fabrics

Weight 405 g/m² | 11.94 oz/yd²

Abrasion resistance 40.000 Martindale, 50,000 Wyzenbeek

Flammability EU: EN 1021.1/2006 | BS EN 1021.1/2006 (cigarette).

EN 1021.2/2006 | BS EN 1021.2/2006 (match)

USA: CAL TB 117 | ASTM E84 CLASS A

Fastness to light EU: 4 | USA 4

Fastness to rubbing EU: Wet 3-4 | Dry 4-5

Fastness to crocking USA: Wet 5 | Dry 5



Finishes

Wood (not for Edel Long)



Ash Black Stained



Ash White Wash

Fixing Systems

Fixing System Ceiling Suspended

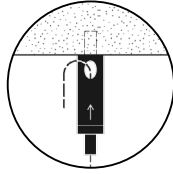
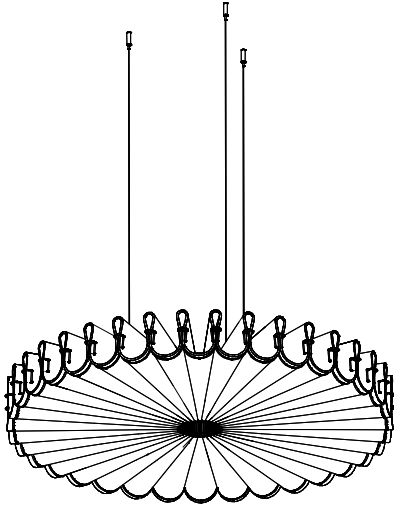

Fixing System Screw

- Black metal support
- 3 cables of 2 or 5 m | 78.74" or 196.85"
- Black or aluminium colored cables

Formations, as with other architectural features located in the ceiling plane, may obstruct or skew the existing or planned fire sprinkler water distribution pattern, or possibly delay the activation of the fire sprinkler or fire detection system. Designers and installers are advised to consult a protection engineer, NFPA 13, and their local codes for guidance on the proper installation techniques where detection or suppression systems are present.

Fixing System Wall

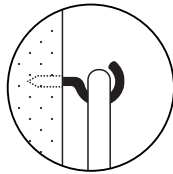
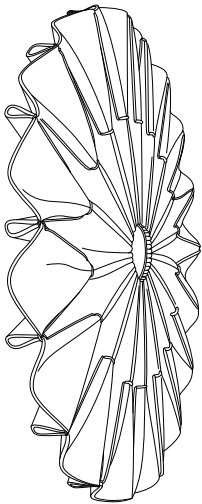

Fixing System Wall

Only Edel and Edel Long are available for Wall Mounting!

- Black metal support
- Wooden center in Ash Black Stained in combination with Black lace or Ash White Wash in combination with an OffWhite lace (Only for Edel)
- Excluding mounting hook

Dimensions

BuzziPleat Ripple

M Ø 100 cm | 39.37"
L Ø 150 cm | 59.06"
d Ø 10 ~ 12 cm | 3.94" ~ 4.72"

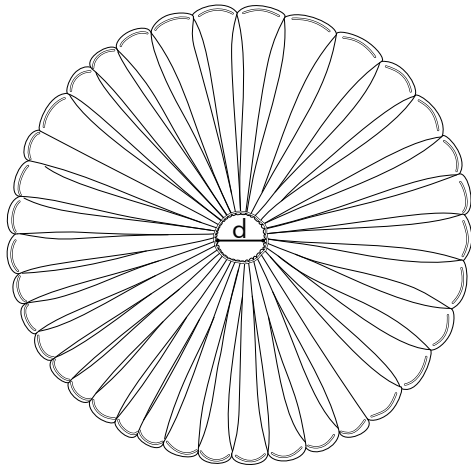

M 13 cm | 5.21"
L 19,5 cm | 7.68"

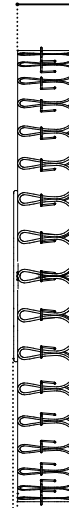

1 cm | 0.39"

BuzziPleat Edel

M Ø 100 cm | 39.37"
L Ø 150 cm | 59.06"
d Ø 10 ~ 12 cm | 3.94" ~ 4.72"

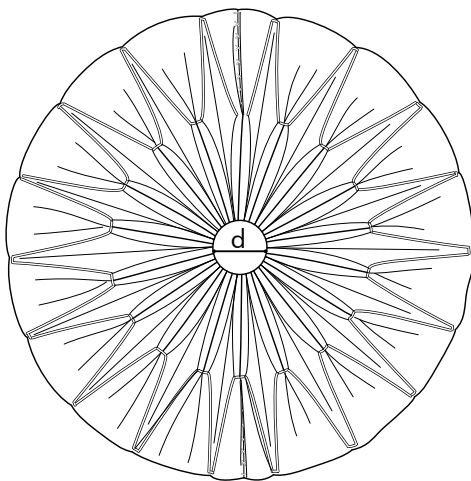

M 9 cm | 3.54"
L 13,5 cm | 5.31"



1 cm | 0.39"

BuzziPleat Edel M Long

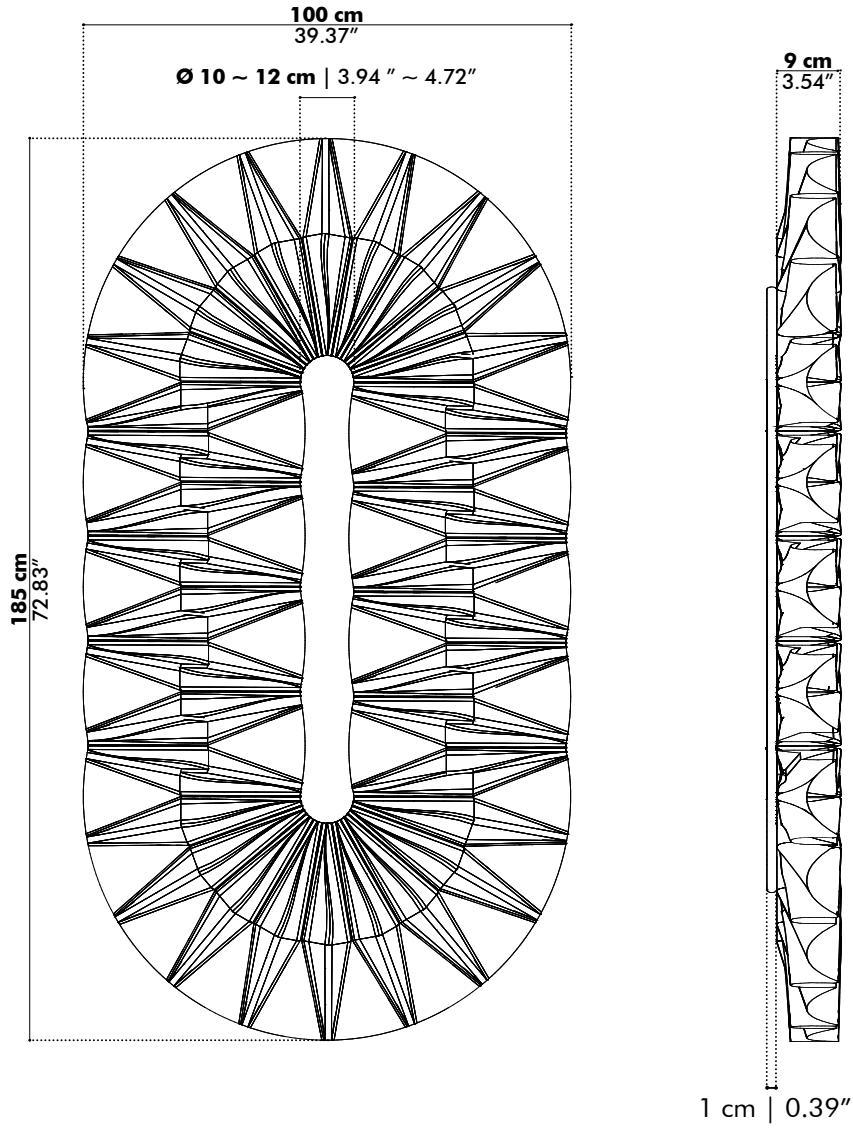

Acoustics

BuzziPleat Ceiling

Equivalent sound absorption area in m² per object

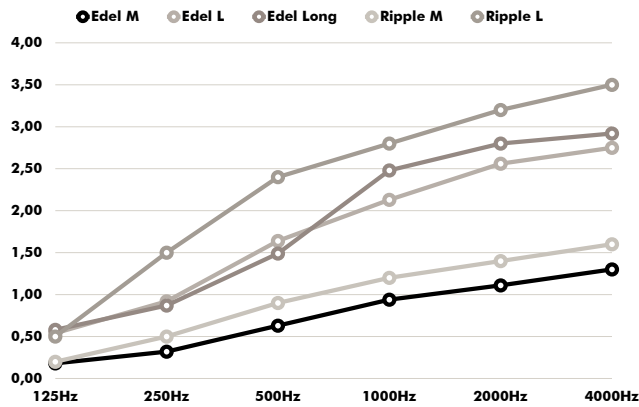

Hz	Edel M Aeq/m ²	Edel L Aeq/m ²	Edel Long Aeq/m ²	Ripple M Aeq/m ²	Ripple L Aeq/m ²
125	0.18	0.54	0.58	0.20	0.5
250	0.32	0.92	0.87	0.50	1.50
500	0.63	1.64	1.49	0.90	2.40
1000	0.94	2.13	2.48	1.20	2.80
2000	1.11	2.56	2.80	1.40	3.20
4000	1.30	2.75	2.92	1.60	3.50

BuzziPleat Wall

Equivalent sound absorption area in m² per object

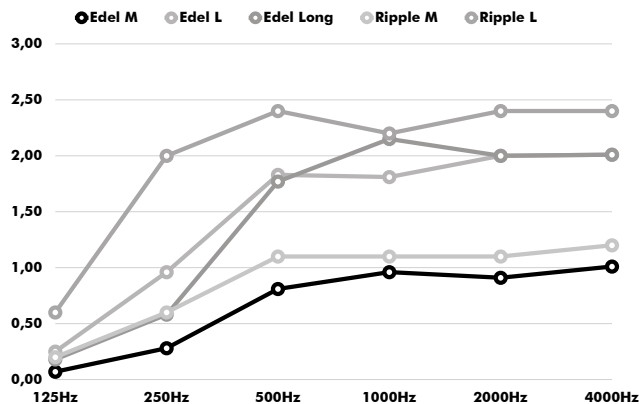

Hz	Edel M Aeq/m ²	Edel L Aeq/m ²	Edel Long Aeq/m ²	Ripple M Aeq/m ²	Ripple L Aeq/m ²
125	0.07	0.25	0.18	0.20	0.60
250	0.28	0.96	0.58	0.60	2.00
500	0.81	1.83	1.77	1.10	2.40
1000	0.96	1.81	2.15	1.10	2.20
2000	0.91	2.00	2.00	1.10	2.40
4000	1.01	2.01	2.01	1.20	2.40