

# convex bookcase

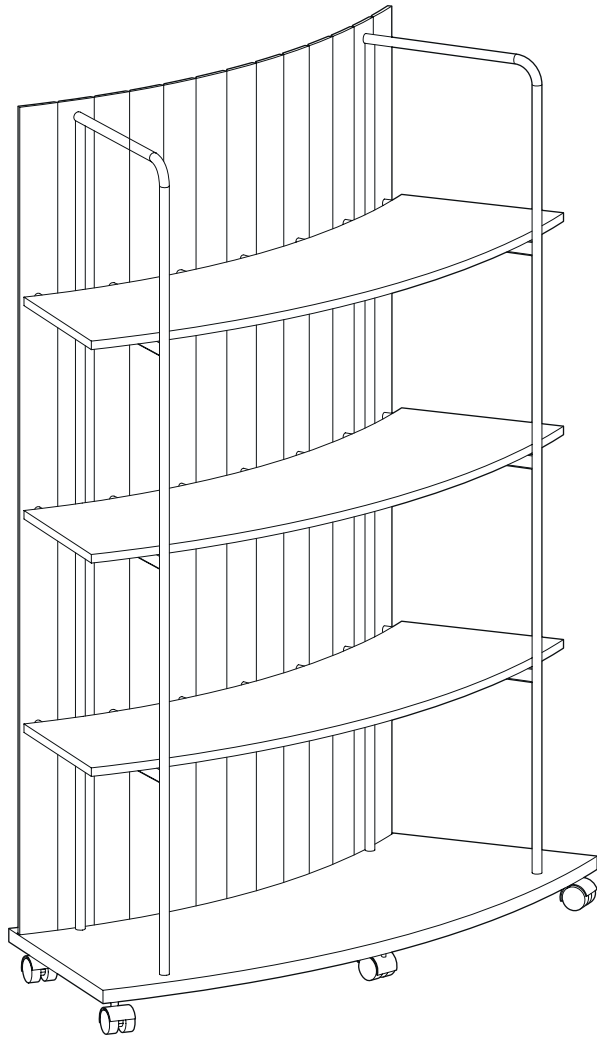

# components

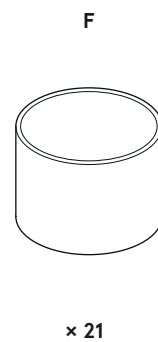

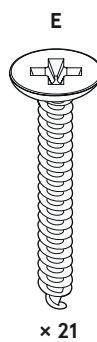
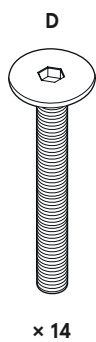
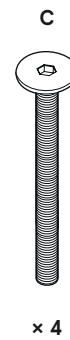
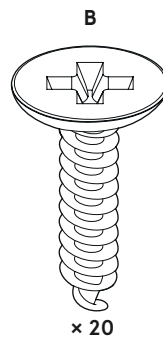
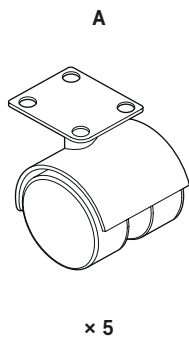
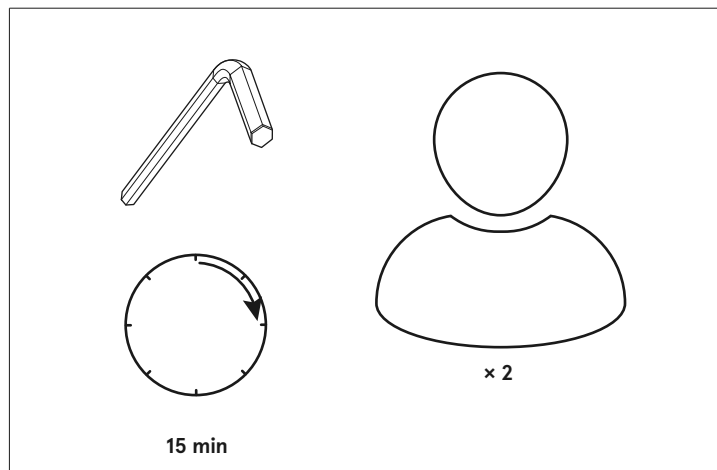
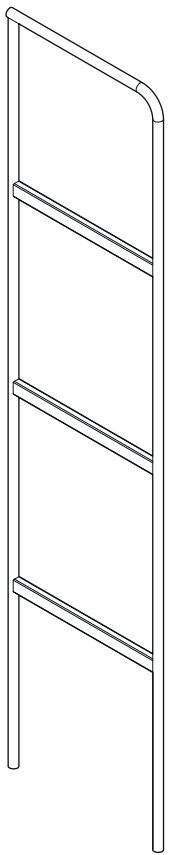

**× 2**

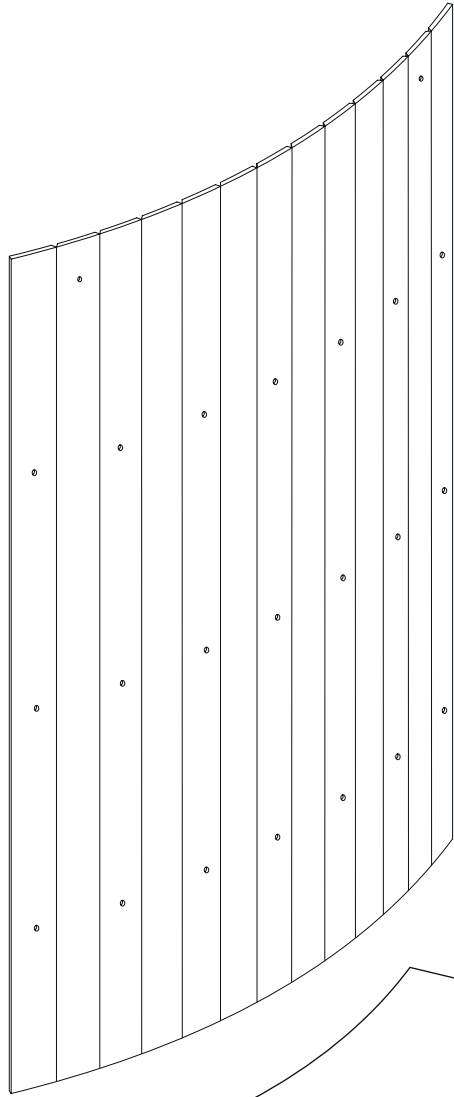

**× 1**

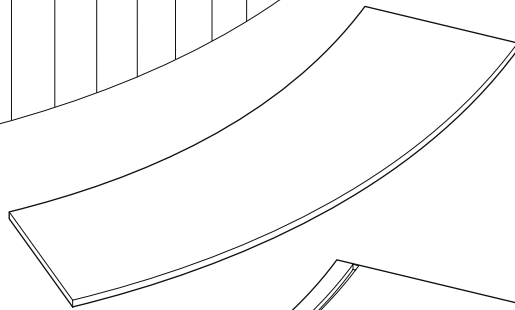

**× 3**

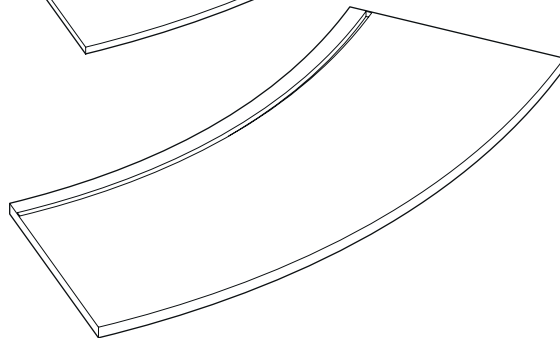

**× 1**

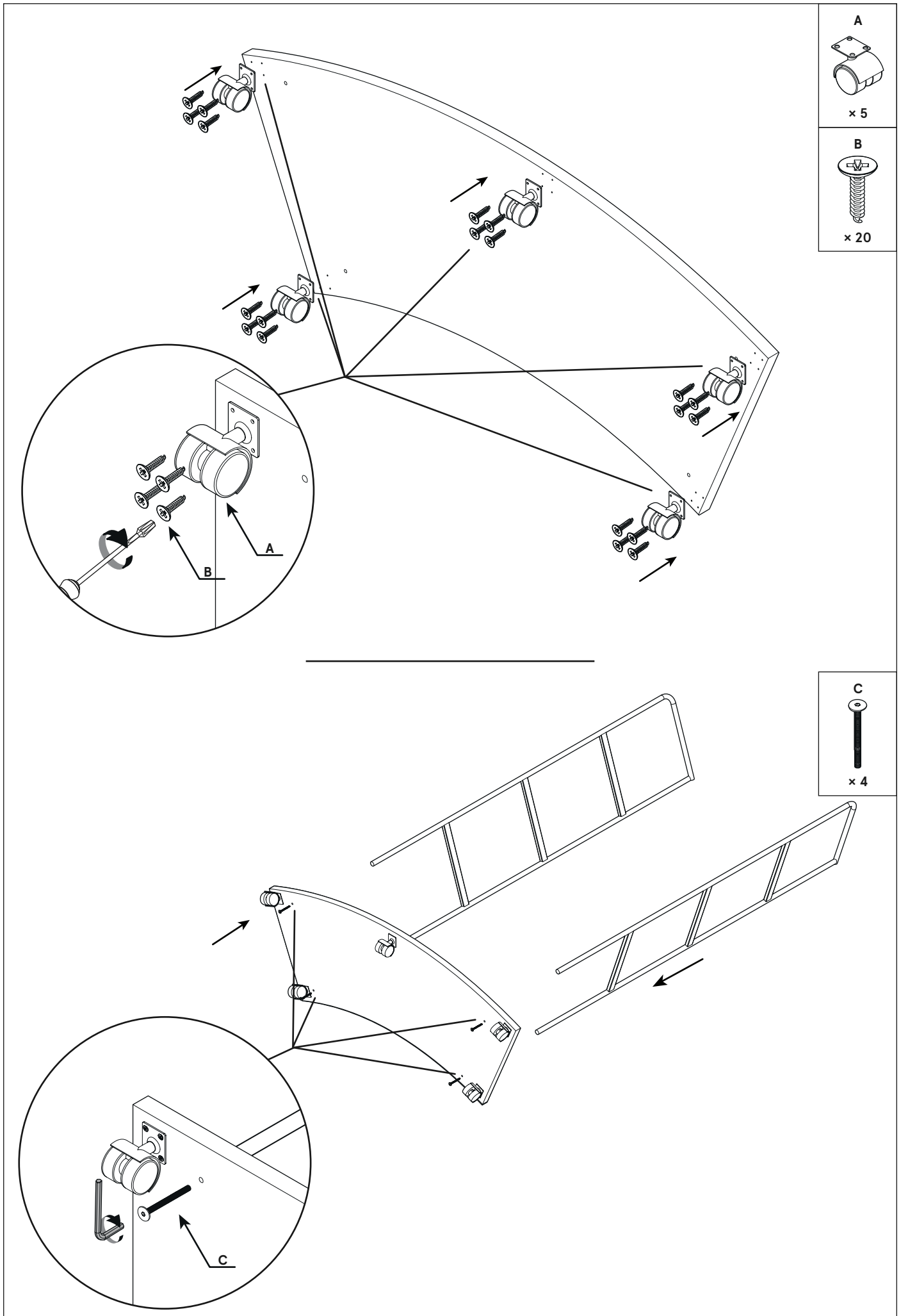

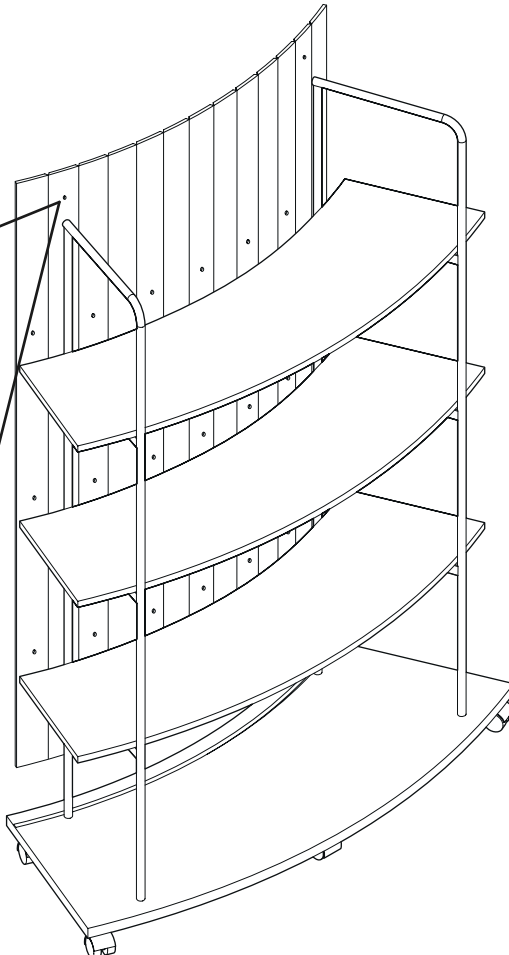
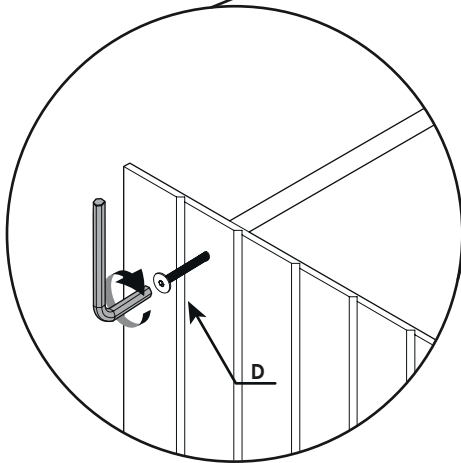
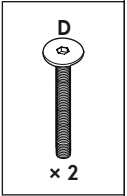
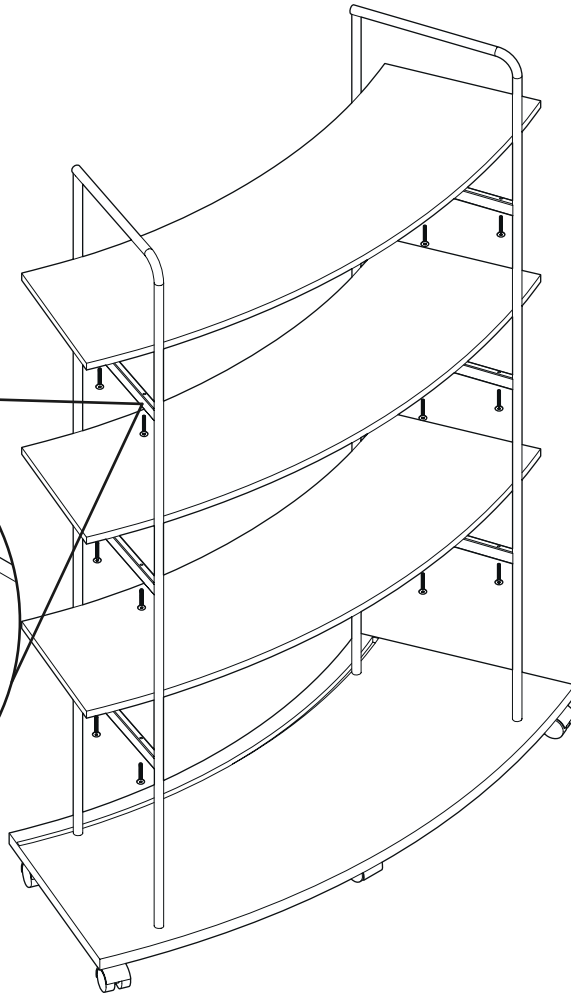
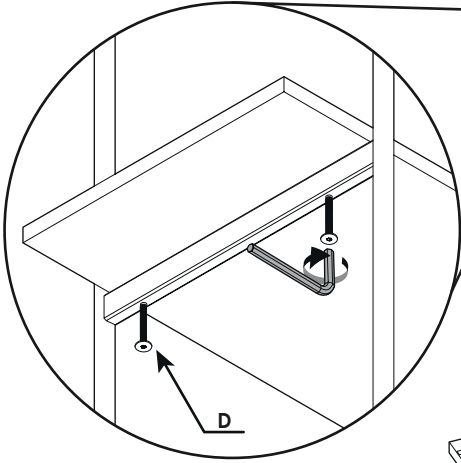
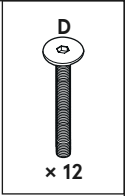

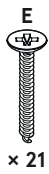

× 21

F



× 21

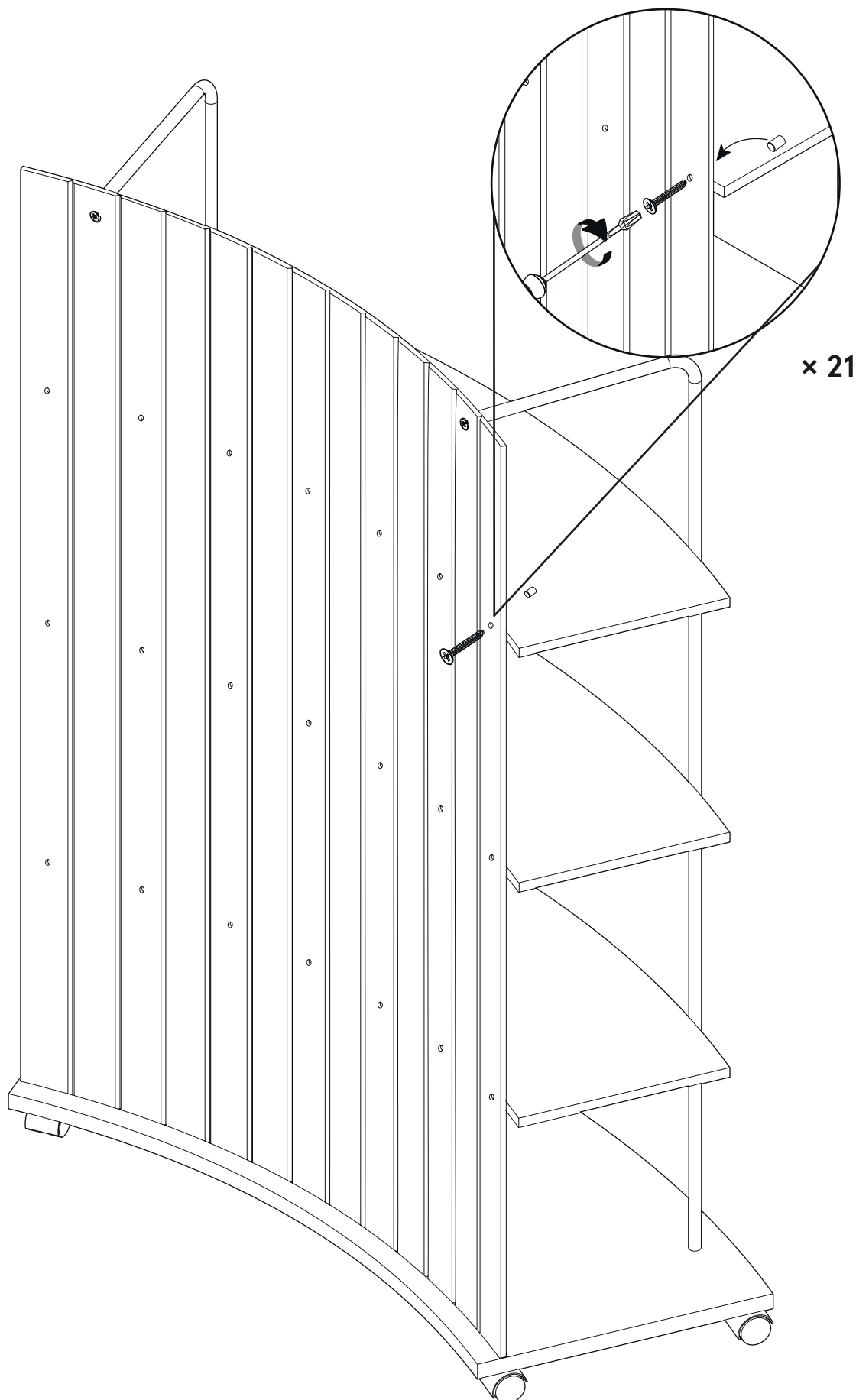

× 21