



---

# BuzziMood

## Product Specification Sheet

---

This document contains technical information about the BuzziMood

---







[www.buzzi.space](http://www.buzzi.space)

## Lift up your mood

Let your imagination run wild and create your own graphic wall art. BuzziMood is an acoustical wall solution that offers the possibility to combine materials found in nature with upholstered pads in a range of different fabrics and geometrical shapes. This blend mitigates noise and serves as a natural air humidity indicator too when mixed with moss panels. Choose between two moss colors, a light and dark green, to create varying degrees of contrast against the metal frames. As the name suggest, this acoustic solution will undoubtedly lift up your mood in any setting.

Design by Cory Grosser

## General

-  BuzziMood Round | Square D | Square Leaf | Rectangular D | Rectangular Leaf  
Wall mounted
-  Frame: powder coated metal in Black (RAL 9005) or Fluo Yellow (RAL 1016)  
Back: MDF
-  Dry use
-  Assembled

---

## Acoustics



Absorption



Mid tone



High tone

---

## Content



Configurations	3
Moss	5
Fabrics	5
Fixing System	8
Dimensions	9
Acoustics	11

# Configurations

---

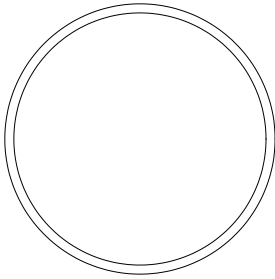
## BuzziMood Round





-  Filling: Reindeer moss or acoustic foam  
Frame: powder coated metal in Black (RAL 9005) or Fluo Yellow (RAL 1016)  
Back: MDF
-  Ø 60 cm H 7,5 cm  
Ø 23.62" H 2.95"
-  Upholstered: 4,9 kg | 10.80 lbs  
Moss: 5,2 kg | 11.46 lbs

---

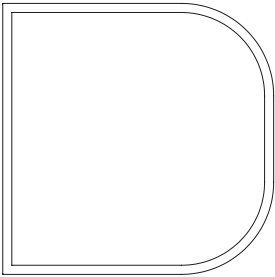
## BuzziMood Square D





-  Filling: Reindeer moss or acoustic foam  
Frame: powder coated metal in Black (RAL 9005) or Fluo Yellow (RAL 1016)  
Back: MDF
-  W 60 cm D 60 cm H 7,5 cm  
W 23.62" D 23.62" H 2.95"
-  Upholstered: 5,6 kg | 12.35 lbs  
Moss: 6,2 kg | 13.67 lbs

---

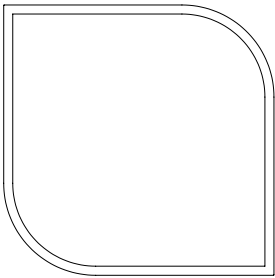
## BuzziMood Square Leaf





-  Filling: Reindeer moss or acoustic foam  
Frame: powder coated metal in Black (RAL 9005) or Fluo Yellow (RAL 1016)  
Back: MDF
-  W 60 cm D 60 cm H 7,5 cm  
W 23.62" D 23.62" H 2.95"
-  Upholstered: 5,6 kg | 12.35 lbs  
Moss: 6,2 kg | 13.67 lbs

---

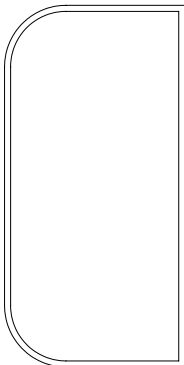
## BuzziMood Rectangular D



-  Filling: Reindeer moss or acoustic foam  
Frame: powder coated metal in Black (RAL 9005) or Fluo Yellow (RAL 1016)  
Back: MDF
-  W 120 cm D 60 cm H 7,5 cm  
W 47.24" D 23.62" H 2.95"
-  Upholstered: 10,5 kg | 23.15 lbs  
Moss: 11,6 kg | 25.57 lbs

---

## BuzziMood Rectangular Leaf

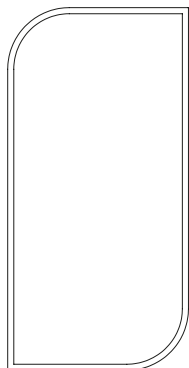

Filling: Reindeer moss or acoustic foam



Frame: powder coated metal in Black (RAL 9005) or  
Fluo Yellow (RAL 1016)

Back: MDF



W 120 cm D 60 cm H 7,5 cm

W 47.24" D 23.62" H 2.95"



Upholstered: 10,5 kg | 23.15 lbs

Moss: 11,6 kg | 25.57 lbs

# Moss

## Light Green



## Dark Green



Make sure the room has an air humidity of 30% or more, that is recommended to keep the moss soft and elastic.

Don't water or spray. Don't install in the close proximity of a heat source or an air conditioning system. Avoid touching the moss.

No claims concerning deviation in color can be accepted, since moss is a natural product and variations in color may occur.

# Fabrics

## Fabric (45 colors)

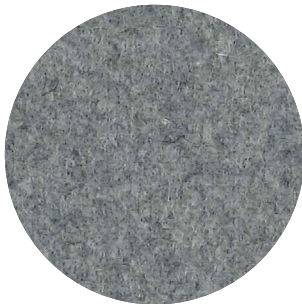

**Category A**

**Composition** 70% Recycled Wool, 25% Recycled Polyacryl,  
5% Recycled Other Fabrics

**Weight** 405 g/m<sup>2</sup> | 11.94 oz/yd<sup>2</sup>

**Abrasion resistance** 40.000 Martindale, 50,000 Wyzenbeek

**Flammability** EU: EN 1021.1/2006 | BS EN 1021.1/2006 (cigarette).  
EN 1021.2/2006 | BS EN 1021.2/2006 (match)  
USA: CAL TB 117 | ASTM E84 CLASS A

**Fastness to light** EU: 4 | USA 4

**Fastness to rubbing** EU: Wet 3-4 | Dry 4-5

**Fastness to crocking** USA: Wet 5 | Dry 5



## Trevira CS+ | CS (47 colors)

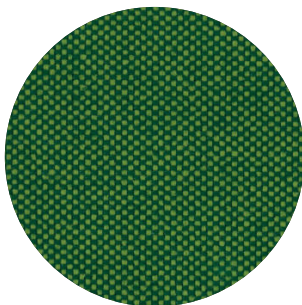

**Category A**

**Weight** 420 g/m<sup>2</sup> | 12.39 oz/yd<sup>2</sup>

**Composition** 100% Polyester, Trevira CS

**Abrasion resistance** 100.000 Martindale, 90,000 Wyzenbeek

**Flammability** BS 5852 part II: CRIB 5 | BS 7176 Medium Hazard  
USA: CAL TB 117 | M1 | B1 | EN 1021/1-2 | C1 |  
IMO Res. A652 (16)

**Fastness to light** EU: 6 | USA 5

**Fastness to rubbing** EU: Wet 4-5 | Dry 4-5

**Fastness to crocking** USA: Wet 5 | Dry 5



## Revive 1 (25 colors)

kvadrat

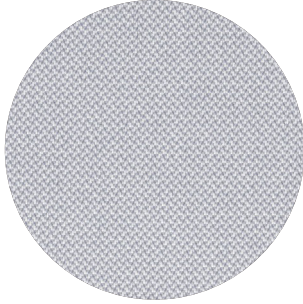

**Category A**

**Composition** 100% recycled polyester FR

**Weight** 430 g/lin.m

**Abrasion resistance** 60.000 Martindale rubs, EN ISO 12947

**Flammability** EN 1021-1/2 | DIN 4102 B1 | Önorm B1/Q1  
UNI 9175 1IM | US Cal. Tech. Bull. 117  
IMO A.652 (16)

**Fastness to light** Note 5-7, ISO 105-B02

**Fastness to rubbing** (ISO) dry 5, wet 4-5

**Pilling** Note 4-5, EN ISO 12945



## Clara 2 (24 colors)

kvadrat

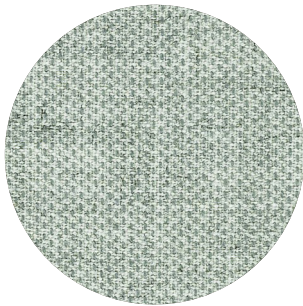

**Category B**

**Composition** 92% new wool, 8% nylon

**Weight** 400 g/lin.m

**Abrasion resistance** 80.000 Martindale rubs, EN ISO 12947

**Flammability** EN 1021-1/2 | BS 5852, ignition source 2-3 | DIN 4102 B2  
NF D 60 013 | UNI 9175 1IM | US Cal. Tech. Bull. 117, Sec. E  
NFPA 260 | IMO A.652(16)

**Fastness to light** Note 5-7, ISO 105-B02

**Fastness to rubbing** (ISO) dry 4-5, wet 4

**Pilling** Note 4, EN ISO 12945



## Remix 3 (73 colors)

kvadrat



**Category B**

**Composition** 90% new wool, 10% nylon

**Weight** 415 g/lin.m

**Abrasion resistance** 100.000 Martindale rubs, EN ISO 12947

**Flammability** EN 1021-1/2 | BS 5852 part 1  
Önorm B1/Q1 | NF D 60 013 | UNI 9175, 1IM  
AS/NZS 1530.3 | Cal. Tech. Bull. 117-2013  
NFPA 260 | IMO FTP Code 2010:Part 8

**Fastness to light** Note 5-7, ISO 105-B02

**Fastness to rubbing** (ISO) dry 4-5, wet 4

**Pilling** Note 4, EN ISO 12945



## Hero 2 (33 colors)

kvadrat

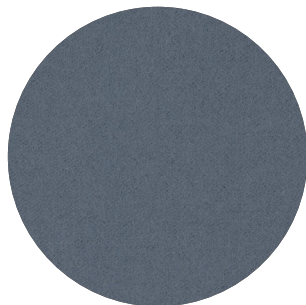

**Category C**

**Composition** 97% new wool, 3% nylon

**Weight** 580 g/lin.m

**Abrasion resistance** 45.000 Martindale rubs, EN ISO 12947

**Flammability** EN 1021-1/2 | DIN 4102 B2 | NF D 60 013  
UNI 9175 1IM | US Cal. Bull. 117-2013 | NFPA 260  
IMO A.652 (16)

**Fastness to light** Note 5-6, ISO 105-B02

**Fastness to rubbing** (ISO) dry 4-5, wet 4-5

**Pilling** Note 3-4, EN ISO 12945



## Tonus 4 (47 colors)

kvadrat

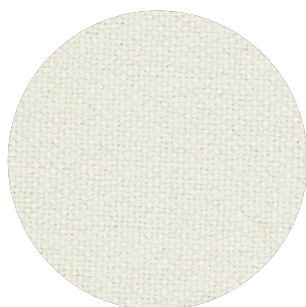

**Category D**

**Composition** 90% new wool, 10% Helanca

**Weight** 665 g/lin.m

**Abrasion resistance** 100.000 Martindale rubs, EN ISO 12947

**Flammability** EN 1021-1/2 | BS 5852 part 1 | DIN 4102 B2  
Önorm B1/Q1 | NF D 60 013 | UNI 9175 1IM  
US Cal. Bull. 117-2013 | NFPA 260 | IMO A.652 (16)

**Fastness to light** Note 5-7, ISO 105-B02

**Fastness to rubbing** (ISO) dry 3-5, wet 3-5

**Pilling** Note 3, EN ISO 12945



## Memory 2 (20 colors)

kvadrat

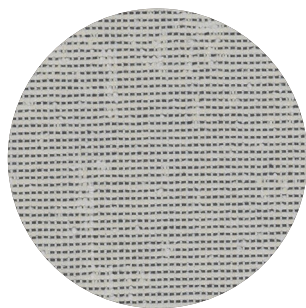

**Category E**

**Composition** 100% Trevira CS

**Weight** 700 g/lin.m

**Abrasion resistance**

35.000 rubs acc. to the Martindale method, EN ISO 12947

**Flammability** EN 1021-1/2 | DIN 4102 B1 | Önorm B1/Q1  
NF D 60 013 | NF P 92 507 M1 | UNI 9175 1IM  
UNI 9177 classe 1 | US Cal. Tech. Bull. 117  
IMO A.652 (16)

**Fastness to light** Note 5-8, ISO 105-B02

**Fastness to rubbing** (ISO) dry 4-5, wet 4-5

**Pilling** Note 4, EN ISO 12945



# Fixing Systems

## Fixing System Wall (included)

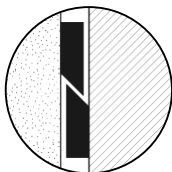
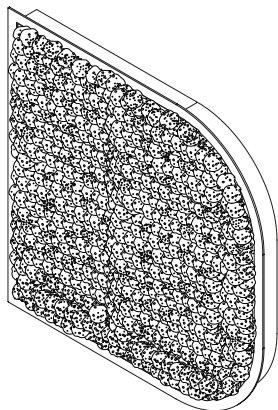

- 1 pc BuzziMood Round | Square D | Square Leaf
- 2 pcs Rectangular D | Rectangular Leaf

Can be mounted horizontally or vertically.

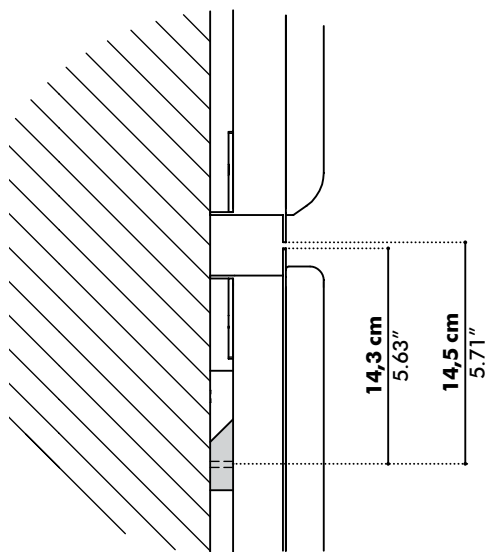



# Dimensions

---

## BuzziMood Round

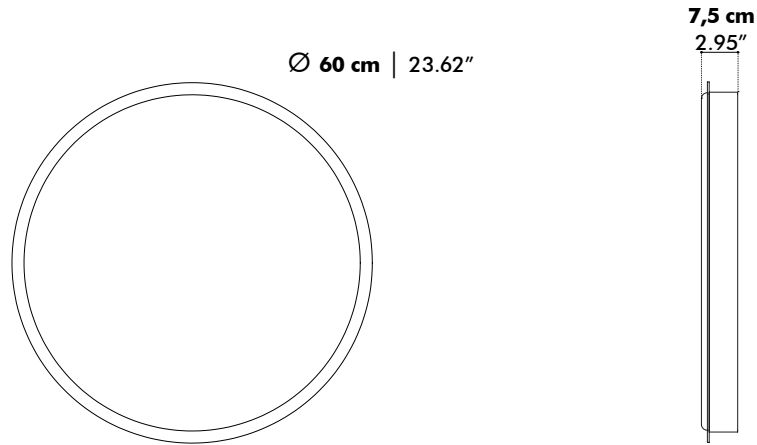

## BuzziMood Square D

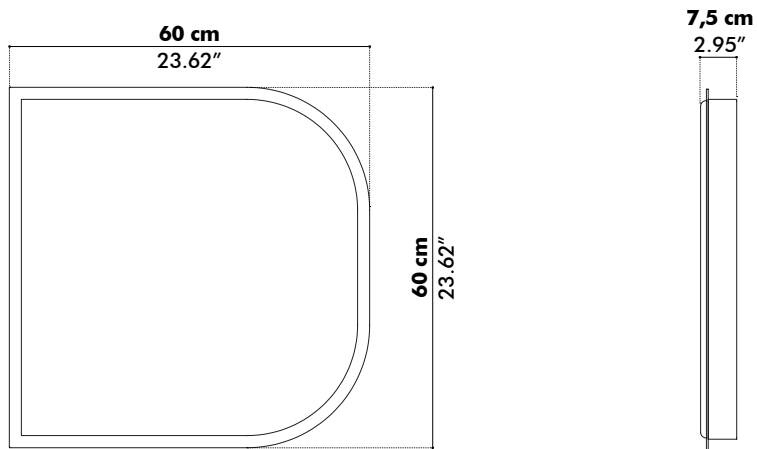

## BuzziMood Square Leaf

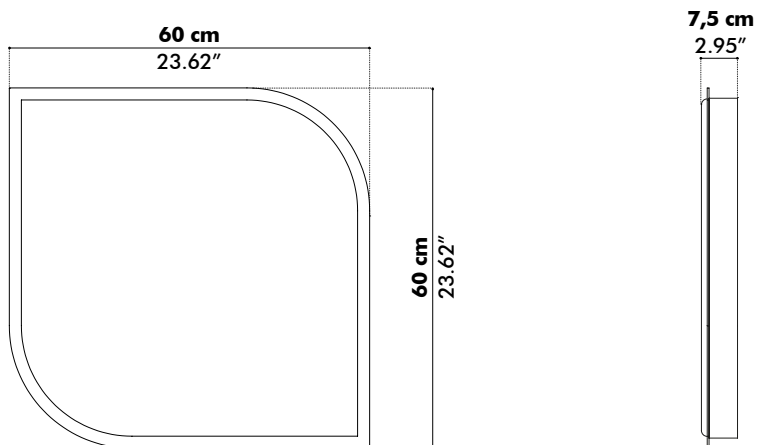

---

# BuzziMood Rectangular D

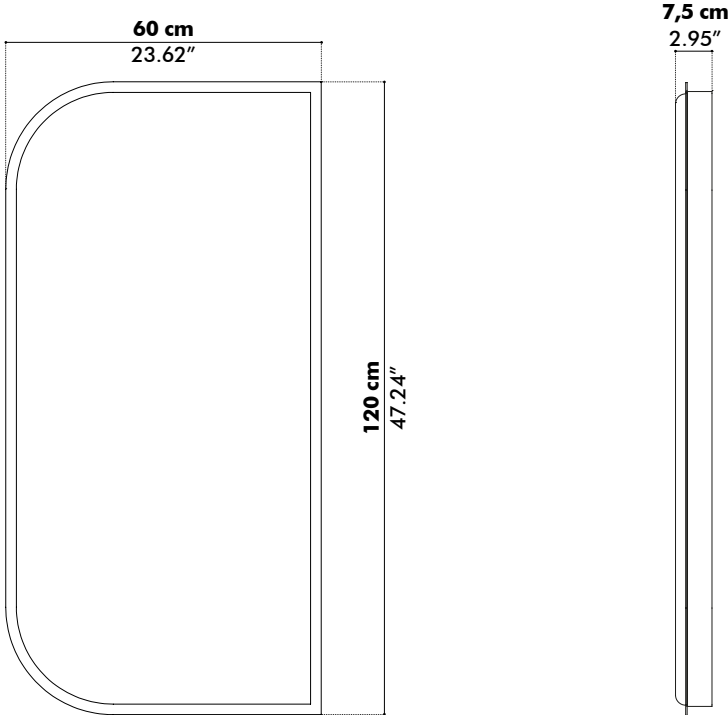

---

# BuzziMood Rectangular Leaf

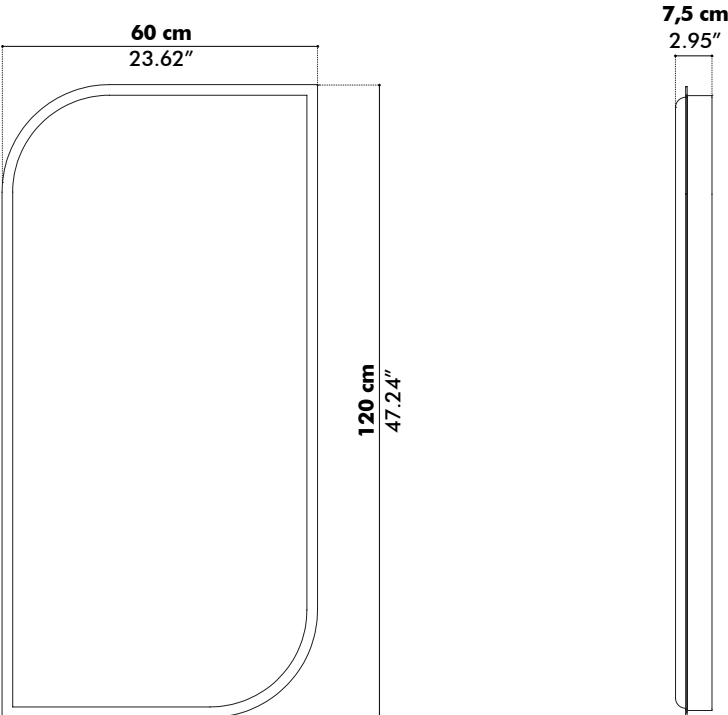

# Acoustics

## BuzziMood Upholstered

### Absorption coefficient

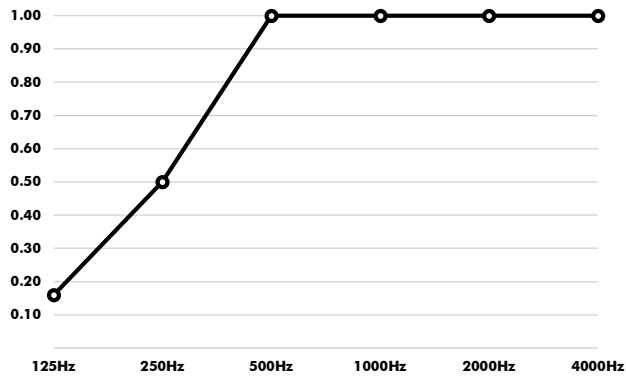

Hz	$\alpha^s$
125	0.16
250	0.50
500	1
1000	1
2000	1
4000	1

### Absorption Values

$\alpha_w$   
(ISO 11654) **0.85**

NRC  
(ASTM - C423) **0.90**

SAA  
(ASTM-C423) **0.90**

## BuzziMood Moss

### Absorption coefficient

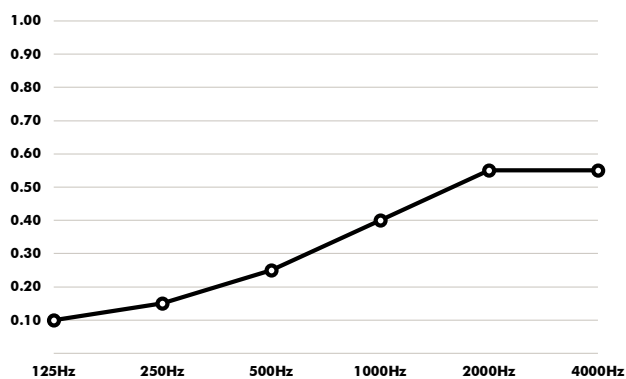

Hz	$\alpha^s$
125	0.1
250	0.15
500	0.25
1000	0.40
2000	0.55
4000	0.55

### Absorption Values

$\alpha_w$   
(ISO 11654) **0.35**

NRC  
(ASTM - C423) **0.35**

SAA  
(ASTM-C423) **0.35**

---

## Glossary

All calculations are based on accredited lab measurements, official document available on Buzzi.Space

### Definitions

---

<b><math>\alpha</math></b>	Weighted absorption coefficient	(ISO 11654)
<b>NRC</b>	Noise reduction coefficient	(ASTM - C423)
<b>SAA</b>	Sound absorption average	(ASTM - C423)

### Classification of sound absorbers NEN-EN-ISO 11654

---

<b>A</b>	0.90   0.95   1.0
<b>B</b>	0.80   0.85
<b>C</b>	0.60   0.65   0.70   0.75
<b>D</b>	0.03   0.55
<b>E</b>	0.15   0.25