

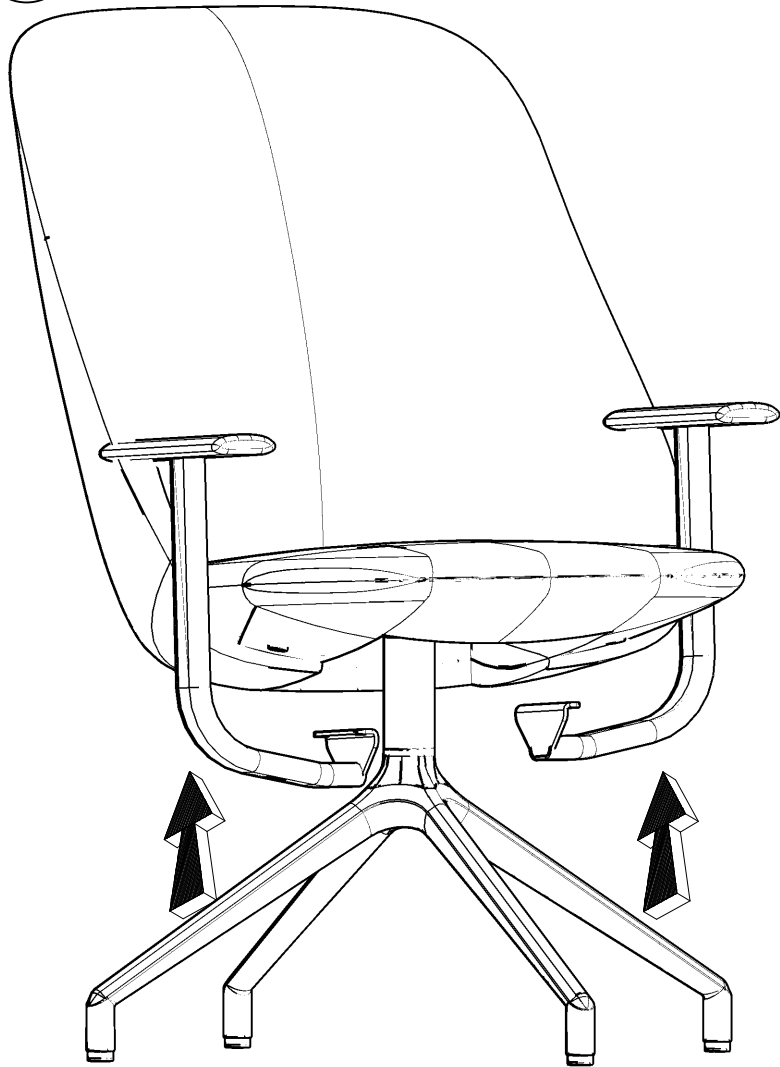

PR2P19

A



B

